

POBROJI KOLIKO IMA VOĆA NA SLICI I ZAOKRUŽI BROJ

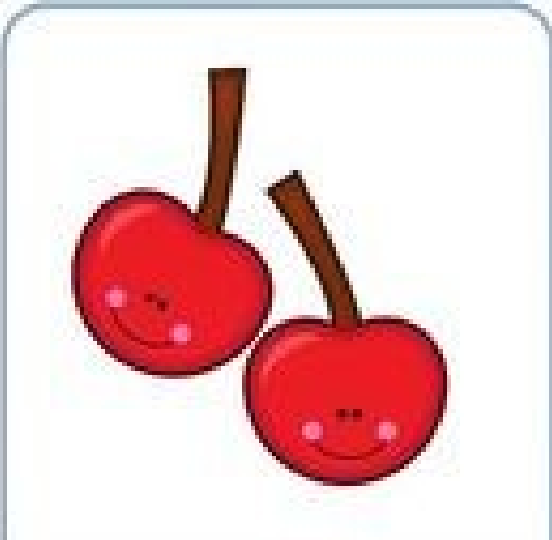

0	1	2
---	---	---



3	4	2
---	---	---

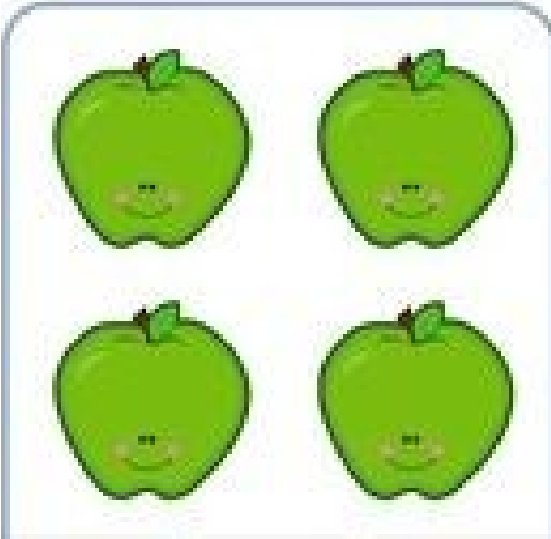



5	4	3
---	---	---





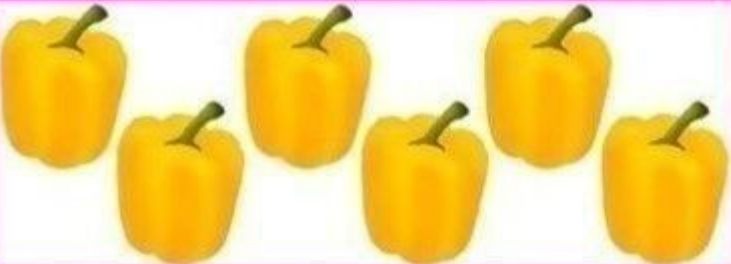
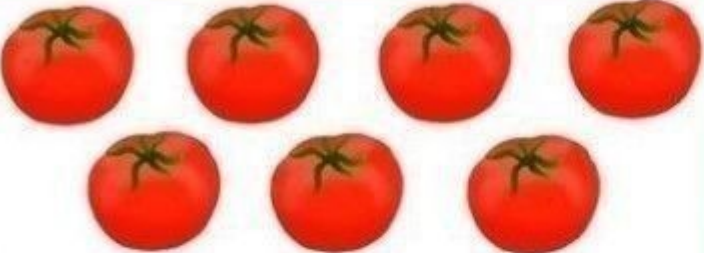

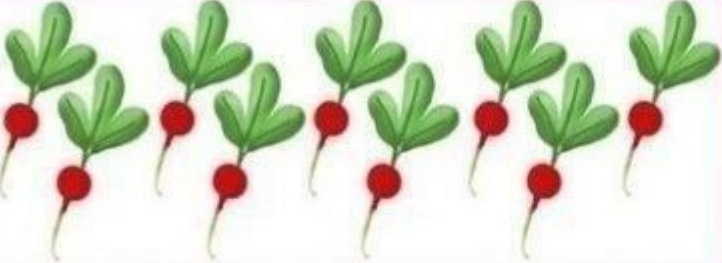
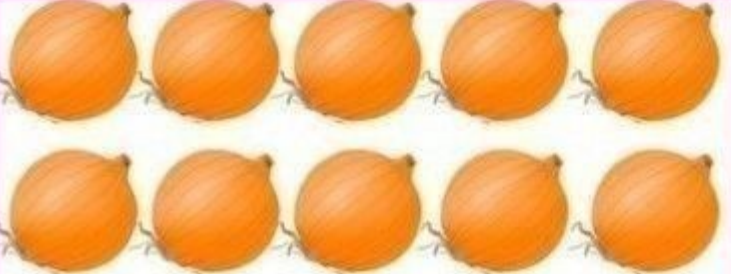

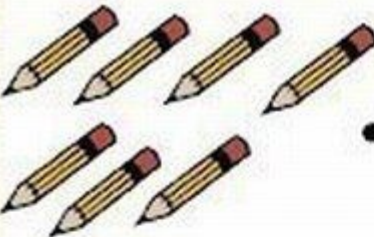

3	2	4
---	---	---

POBROJI I UPIŠI U PRAZAN KVADRATIĆ TOČAN BROJ POVRĆA

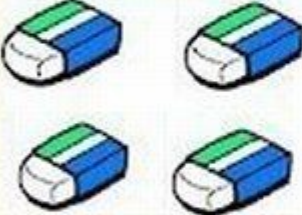
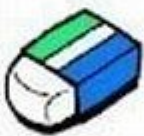
POBROJI PREDMETE I UPIŠI TOČAN BROJ U PRAZAN KVADRATIĆ

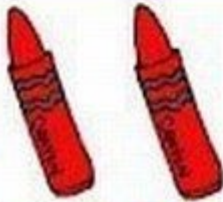
	+		=	
	+		=	
	+		=	
	+		=	
	+		=	

SPOJI SLIKE S NJIHOVOM SJENOM



SPOJI SLIKE S NJIHOVOM SJENOM

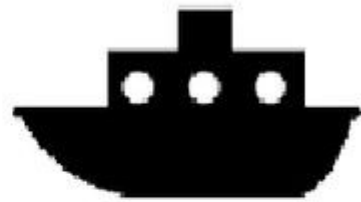

POBROJI TOČKICE NA BUBAMARI TE ZAOKRUŽI BROJ



6	4	3
---	---	---



8	6	7
---	---	---



5	4	9
---	---	---



10	9	8
----	---	---



3	2	8
---	---	---



9	3	6
---	---	---



8	10	6
---	----	---



11	10	9
----	----	---



2	1	3
---	---	---

ZBROJI AUTE TE UPIŠI ZBROJ NA PRAZNU CRTU

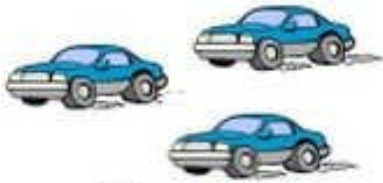

3

+



1

=



1

+



3

=



2

+



2

=



1

+



2

=

POMOZI BUBAMARI PRONAĆI PUT DO LISTA

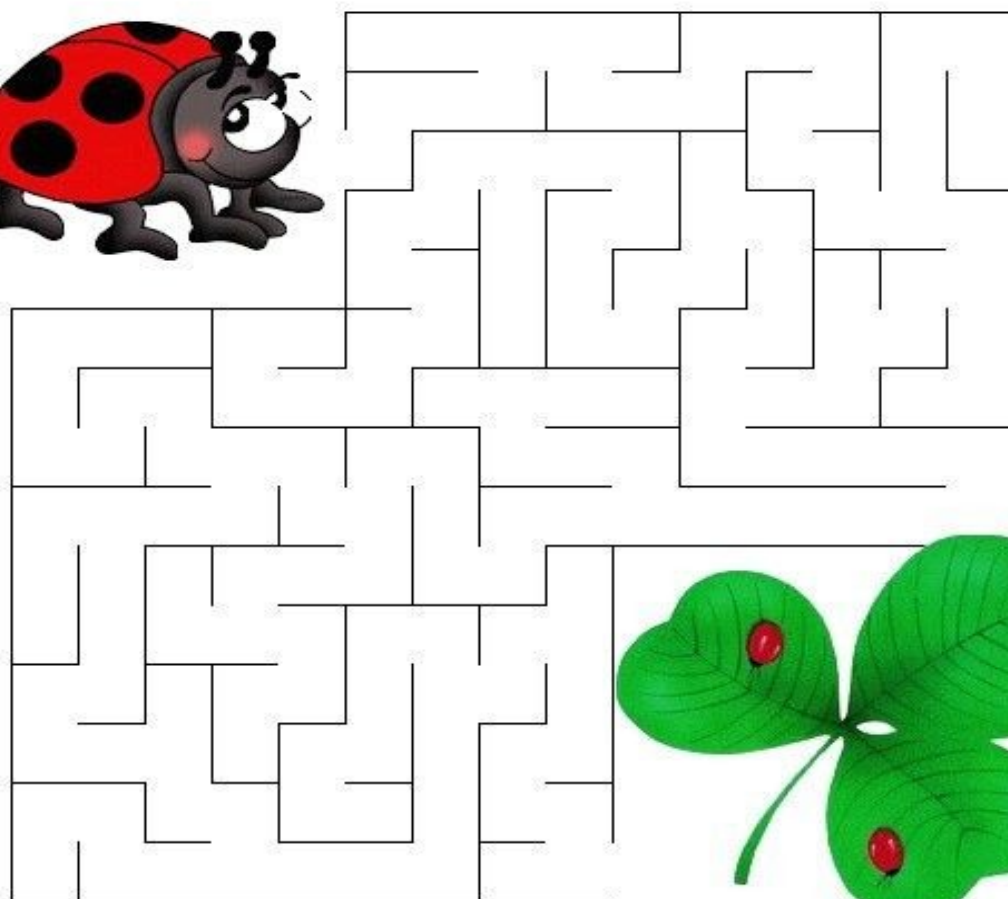

SPOJI OBJEKT SA SJENOM

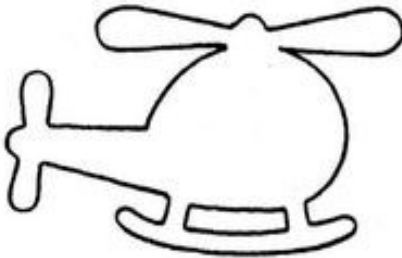
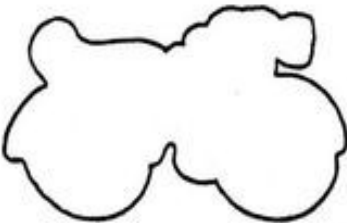
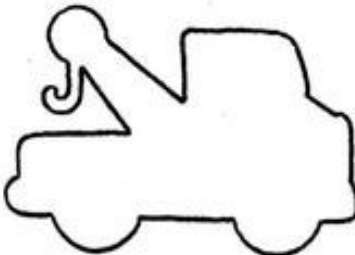
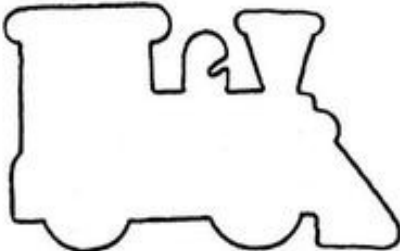
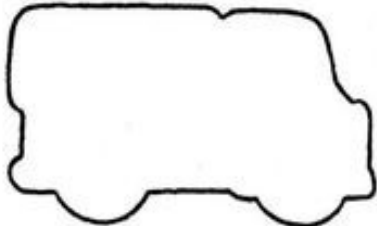
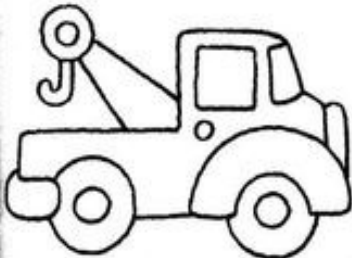
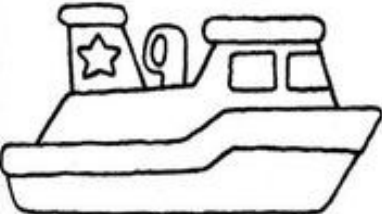
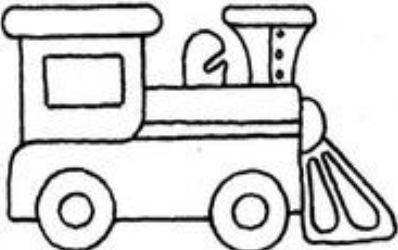
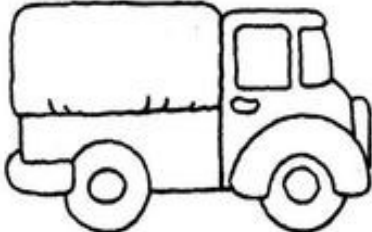
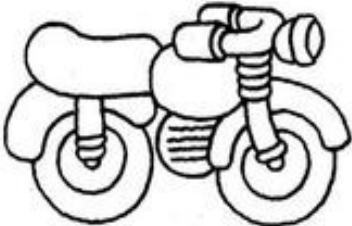

PRONAĐI KOJE ŽIVOTINJE ŽIVE U MORU I ZAOKRUŽI IH



PRONAĐI ŽIVOTINJI DOM - SPOJI

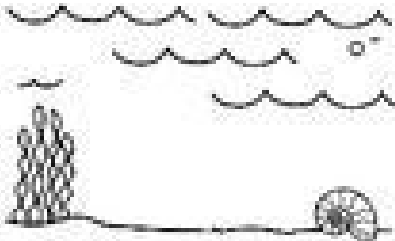
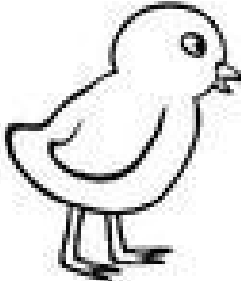
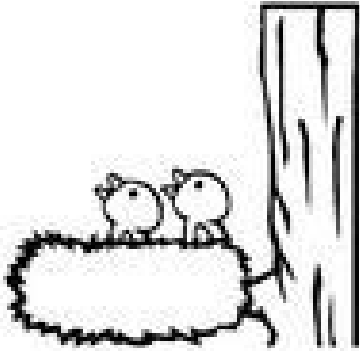
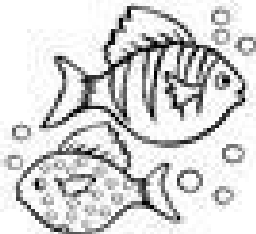
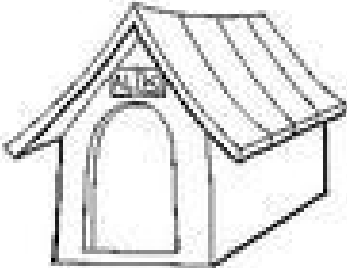
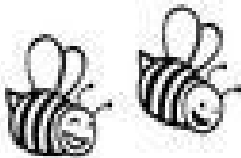
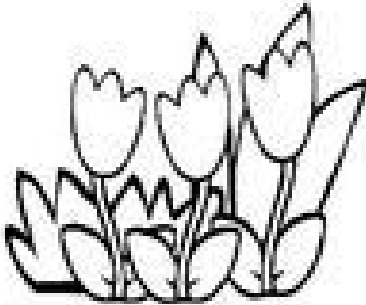
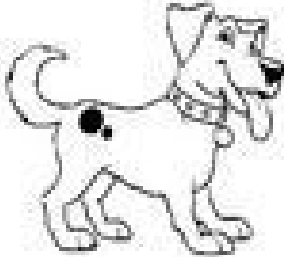

KUDA PUTUJU PRIJEVOZNA SREDSTVA NA SLICI - SPOJI

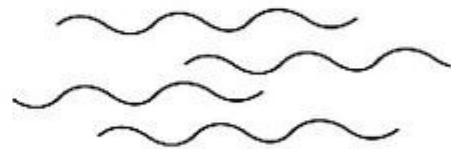
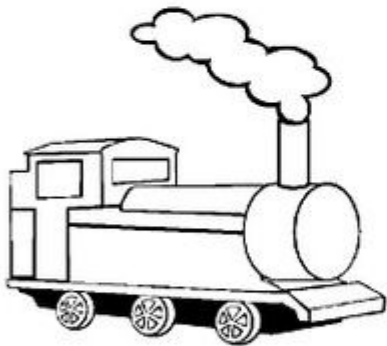

SPOJI JABUKE I TOČKICE NA STABLU

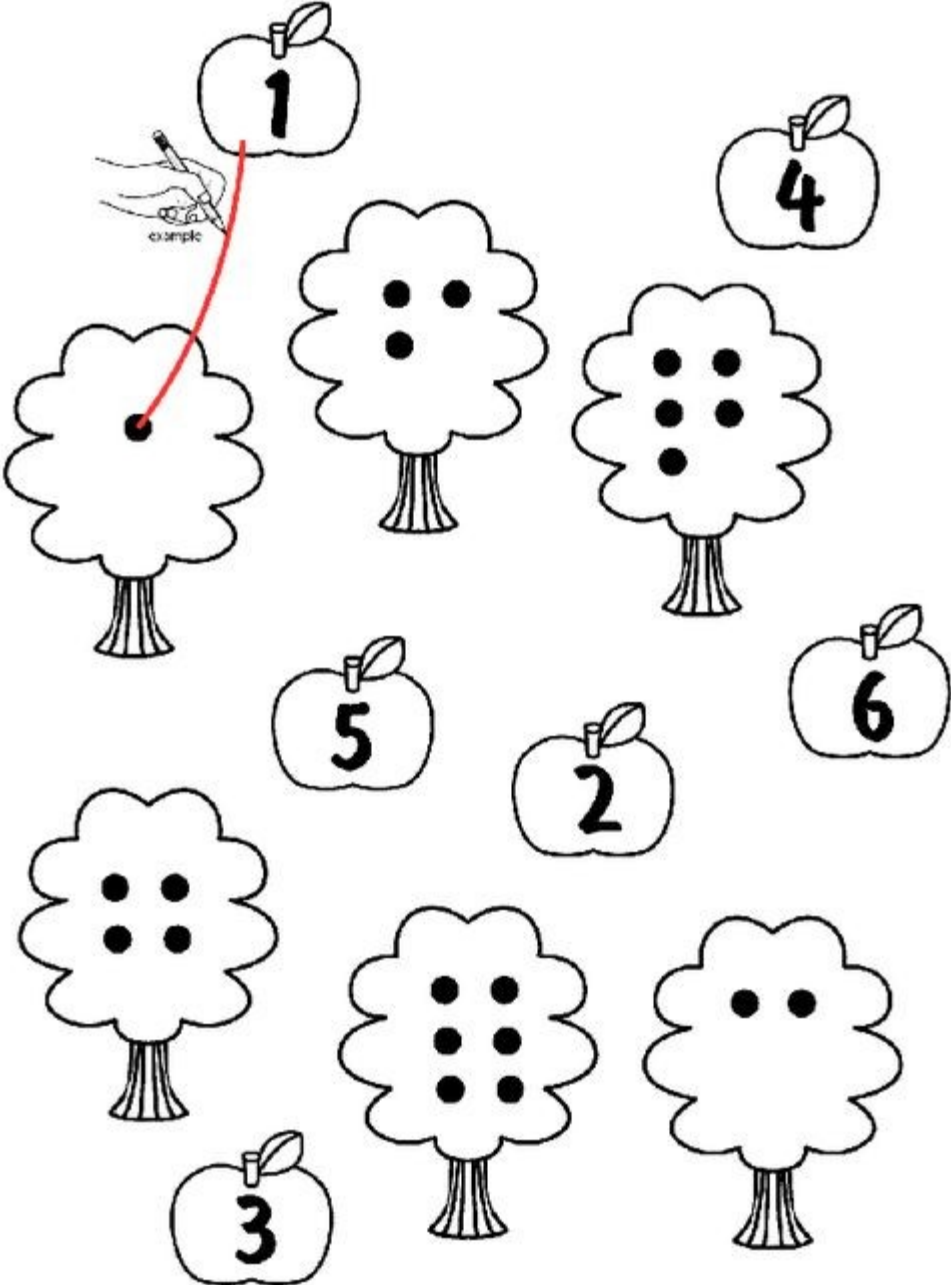

UPIŠI BROJEVE KOJI NEDOSTAJU



PRONAĐI PUT DO PARKA



POMOZI PČELI DOĆI DO CVIJETA

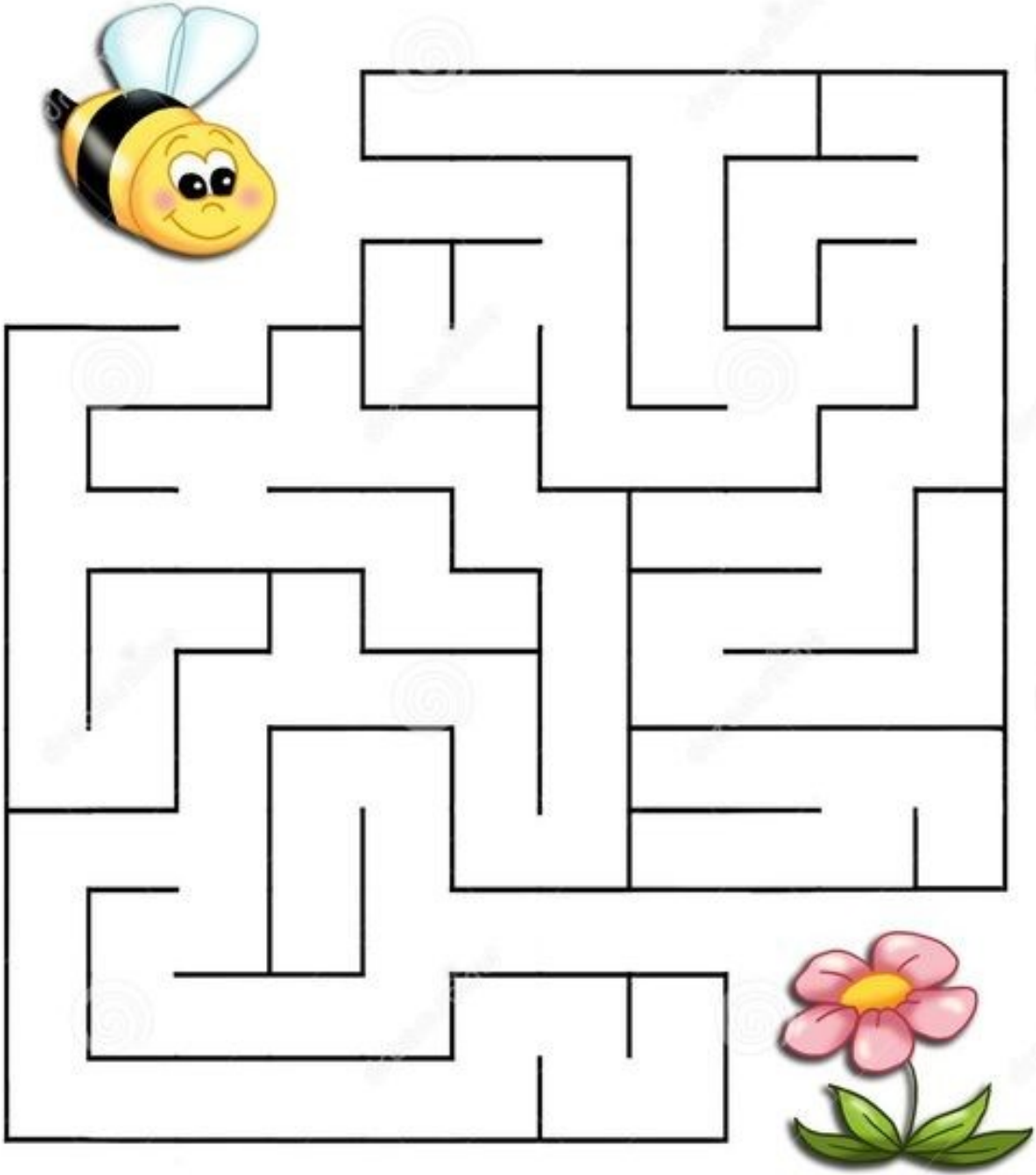

ZAOKRUŽI KRAĆI PREDMET

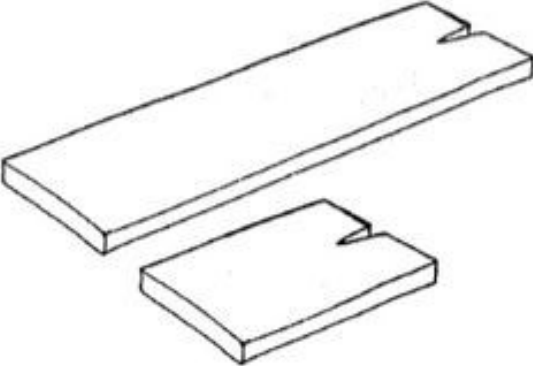
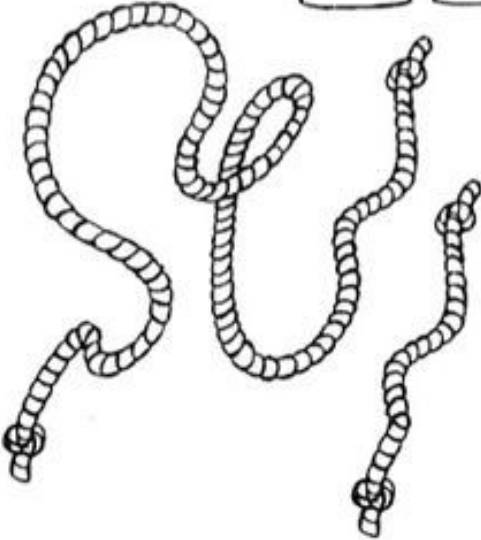
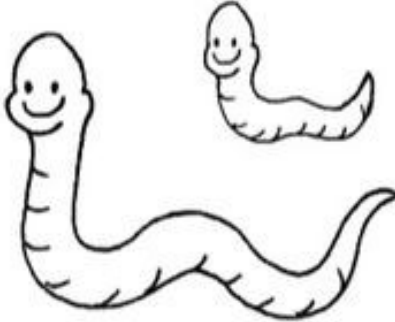
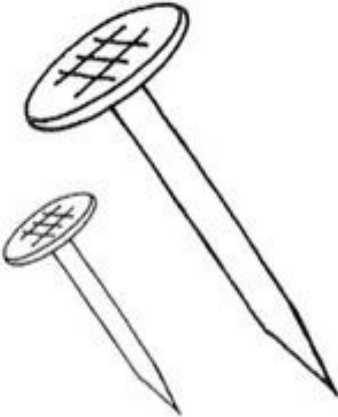
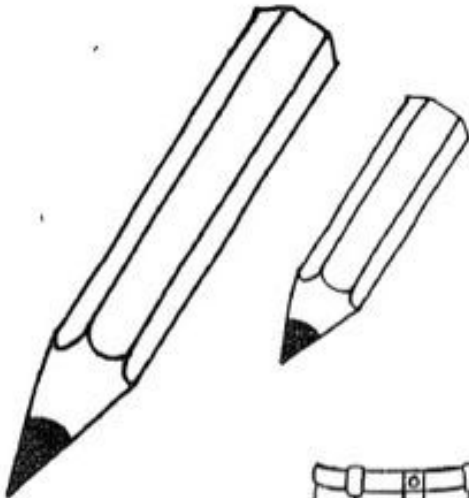

ZAOKRUŽI DEBLJI PREDMET

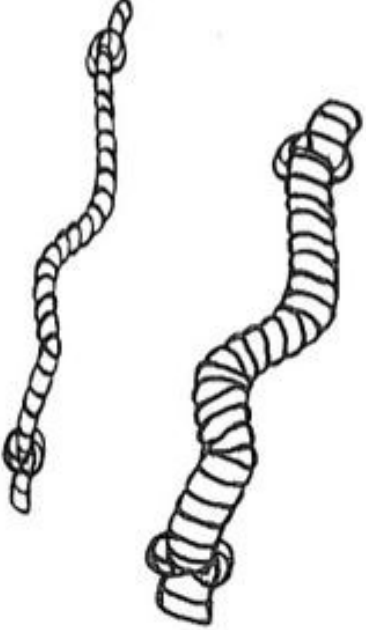
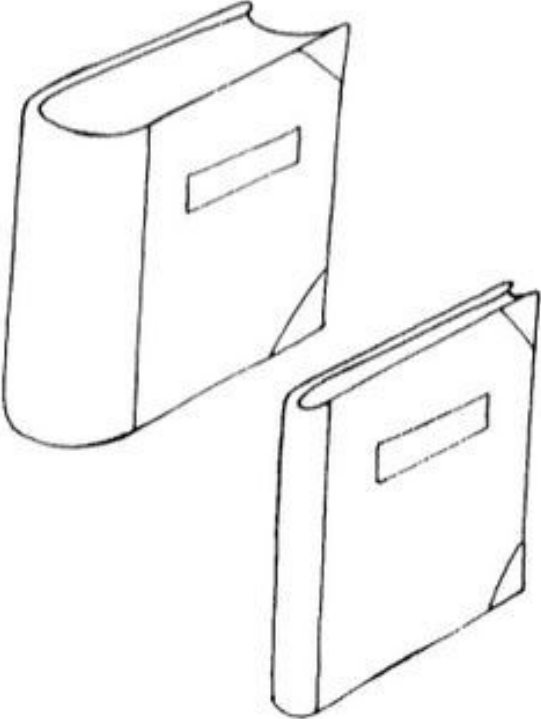
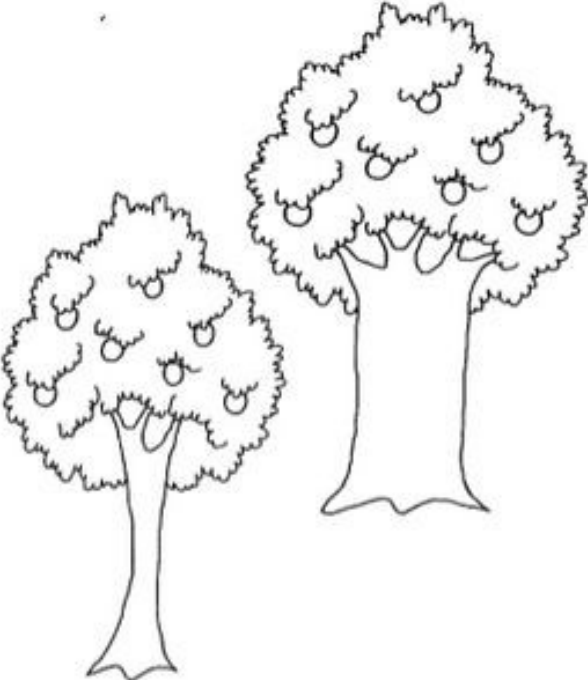

Pronađi 7 razlika i zaokruži ih na donjoj slici

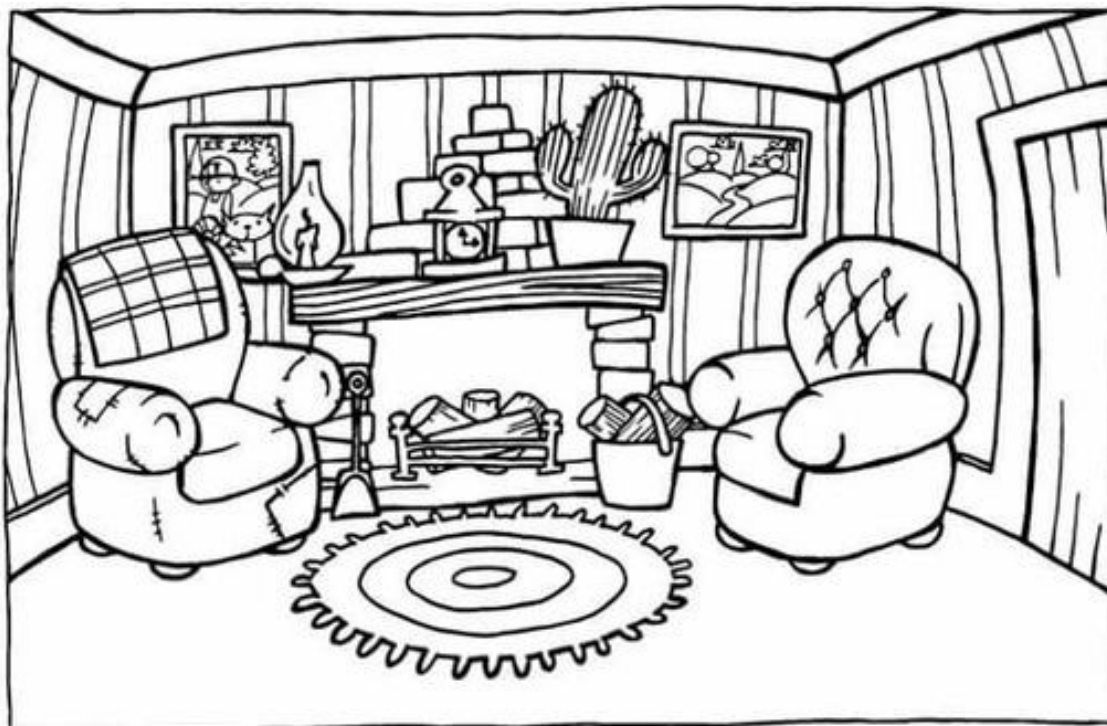

7

